

PORCELAIN VANITIES & BASINS



COMMERCIAL
TAILOR-MADE⁺

CONTENTS

PORCELAIN STONEWARE	
INTRODUCTION	7
WHY PORCELAIN STONEWARE	9
WATER RESISTANCE	11
STAIN & HEAT RESISTANCE	13
SCRATCH RESISTANCE	15
COLLECTION	
LUXURY SINGLE BASINS	17
DOUBLE BASINS	29
FREESTANDING BASINS	43
VANITY TOPS	55
CLOAKROOM BASINS	69
CLOAKROOM VANITY TOPS	77
VANITY SHELVING	85
SPECIFICATION	
CLICK-CLACK WASTE	91
DIMENSIONS	93
WORKING WITH US	
INTRODUCING TAILOR-MADE	103
COLOUR SAMPLES	105
SURFACE SPECIFICATION	
TECHNICAL SPECIFICATION	107
MAINTENANCE	109
SUSTAINABILITY	115
COLOURS	
COLOURS	117



TERRASOLO650 | 650 x 500 x 900 mm | HERITAGE FLAME - POLISHED (FIG.4.1)



VANITYTOP1600 | 1600 x 500 x 130 mm | ONYX MIELE - POLISHED (FIG. 6.1)

EXCLUSIVE PORCELAIN BASINS AND VANITIES

Introducing a dedicated supply solution designed specifically for commercial and residential developers, architects, interior designers, and contractors. Exclusive Italian porcelain stoneware basins and vanity tops, carefully crafted at our UK manufacturing studio.

Over fifty distinctive designs have been introduced, including marble, onyx, granite and stone, providing a manufacturing and design solution for the highest quality bathroom projects.

High-performance porcelain tops are renowned for their strength and durability, offering one of the hardest and most beautiful surfaces available. With exceptional longevity, porcelain vanities and basins maintain their lustre and resist water damage, ensuring lasting value and customer satisfaction.

We are committed to providing the best product and service solutions to our clients. This formulated marketing assistance, includes 3D models and a colour sampling service, enabling you to effectively showcase these premium vanities and seamlessly integrate them into your schemes.



TERRASOLO650 | 650 x 500 x 900 mm | ONYX PERLA - POLISHED (FIG. 8.1)

PORCELAIN STONEWARE

Basins and vanity tops need to perform under challenging conditions. These types of surfaces are constantly exposed to water, and wear and tear from continual use. It is under these intensive conditions that porcelain stoneware excels, exhibiting one of the hardest, and most beautiful surfaces available on the market. Porcelain stoneware maintains its lustre and will not fade or deteriorate over time, and where stone and natural marble tops may suffer continual damage from water, porcelain's tough surface has been designed to withstand daily wear and tear.

Porcelain stoneware has a durable, scratch-resistant finish that is heat and stain resistant and does not require sealing. The surface offers protection against mould and mildew that cause odours, while make-up, soap, and cleaning products will not stain. Its non-porous surface prevents bacteria build-up, protecting your customers and ensuring the longevity of your products.

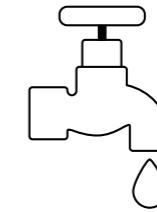

WATER RESISTANCE

Unlike many natural materials including stone and marble, porcelain is entirely non-porous. This provides an extremely hygienic, anti-bacterial surface that is easy to clean and keep streak-free. Scientific evidence has demonstrated that porous materials foster bacterial proliferation more than non-porous materials. As porcelain is a compact, non-porous material, it is particularly suitable for surfaces that require a hygienic, anti-bacterial surface, both in the home and within commercial washroom settings such as hotels and restaurants.

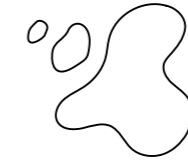

STAIN RESISTANCE

Market leading stain resistance mean that daily products like coffee, make-up and soap will not stain. As the material is impenetrable, even the most stubborn watermarks and limescale residues can be easily removed. These substances can be easily wiped away without the use of chemical products. This reduces the environmental impact further as chemical products are no longer required.

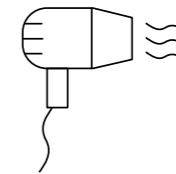

HEAT RESISTANCE

Due to the unrivalled technical performance of porcelain, high temperatures and sudden thermal changes do not affect the surface, so hair dryers and hot styling tools can be safely placed on its surface. Porcelain surfaces are resistant to high temperatures and thermal shock in accordance with European Standard EN14617, to wet heat in line with European Standard EN12721, and to dry heat in line with EN12722.

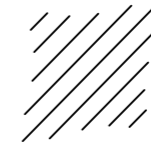
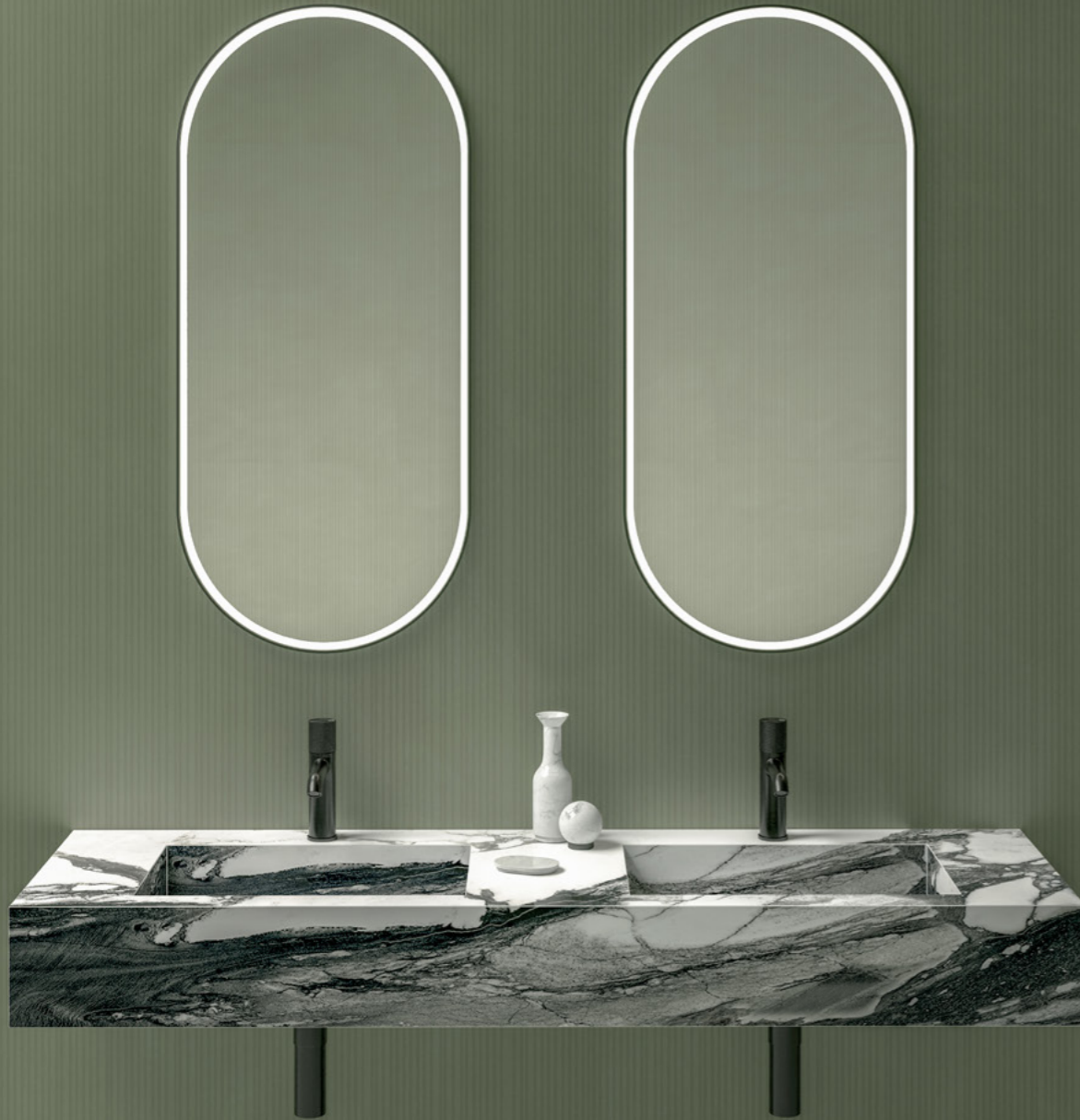

SCRATCH RESISTANCE

Hard working surfaces need to perform under extreme conditions and are constantly exposed to potential scratches and scores from sharp objects. With one of the hardest surfaces available, porcelain surfaces maintain a scratch-resistant surface that will not fade, discolour or deteriorate over time. In fact it is so tough that it is regularly specified within professional kitchens and public washrooms.

Is it possible to scratch porcelain tops?

The short answer is yes. Porcelain, like other surfaces, can be scratched. However, porcelain surfaces are more scratch resistant than other countertop surfaces. As a general rule the softer a surface is, the easier it will scratch. Diamonds for example are the hardest known mineral on the planet and are rated 10 on the Mohs scale of hardness. All other minerals are rated 9 or below. Anything with a hardness below that of a diamond cannot scratch a diamond, however this means that a diamond can scratch another diamond.

The same is true for porcelain countertops. Because porcelain is so hard, with a typical Mohs rating of 8, care must be taken when using utensils, vases and tableware that have an equivalent Mohs rating. For example ceramic knives, or ceramic vases (which have a similar composition to porcelain) can scratch the surface, because just like diamonds, porcelain can scratch porcelain.

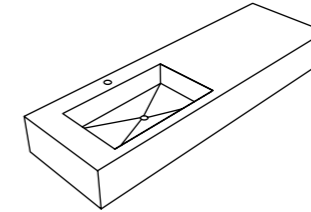

LUXURY SINGLE BASINS

We have introduced a range of luxury wall-mounted single basins, crafted from Italian porcelain surfaces and available in sizes from 1200 mm to 1600 mm in length. Designed for modern bathroom spaces, these basins combine clean lines with practical functionality, making them an ideal choice for a variety of interior styles. The use of high-performance surfaces ensures both durability and easy cleaning, while the wall-mounted design allows for a sleek, space-saving installation.

Versatile installation options can suit different bathroom layouts. They can be installed within an alcove, providing a clean, built-in appearance that integrates seamlessly with surrounding walls. Alternatively, they can be wall-mounted in open space, allowing for a more open and minimalist look.

You can specify the sink placement to be centred or aligned to the left or right, offering greater flexibility in design. We also accommodate different tap configurations, allowing for both wall-mounted and deck-mounted taps to be seamlessly integrated. This versatility ensures that our basins can adapt to a wide range of functional needs.



SOLO1600 | 1600 x 500 x 160 mm | CRYSTAL AMBRA - POLISHED (FIG.18.1)



SOLO1200 | 1200 x 500 x 160 mm | PIETRA GREY - POLISHED (FIG.20.1)







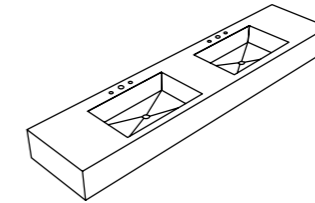

DOUBLE BASINS

A collection of wall-mounted double basins, crafted from premium Italian porcelain slabs and designed for twin bathroom spaces. These basins, available in three sizes (1400, 1600 and 2000 mm), provide ample space for shared use while maintaining a sleek and refined aesthetic. Perfect for modern bathrooms, they offer both functionality and a stylish focal point.

Our double basins offer flexible installation options, whether you need them fitted within an alcove or mounted on an open wall. Alcove installations deliver a built-in look, blending effortlessly with the surrounding architecture, while wall-mounting in open space allows for a more spacious and minimalist feel. Both installation methods ensure a clean, modern design that complements various bathroom layouts.

Additionally, the basins can be specified with sink placement aligned either to the centre or off to the left or right to accommodate different design preferences and spatial needs. We also provide pre-cut holes for deck-mounted taps, giving you full control over the layout and design of fixtures to suit specific applications.



DOPPIO1600 | 1600 x 500 x 180 mm | CALACATTA RENOIR - POLISHED (FIG.30.1)



DOPPIO1600 | 1600 x 500 x 180 mm | CALACATTA RENOIR - POLISHED (FIG.32.1)



DOPPIO2000 | 2000 x 500 x 180 mm | MACCHIA VECCHIA - POLISHED (FIG.34.1)





DOPPIO2000 | 2000 x 500 x 180 mm | GRANITO BLU ANDE - POLISHED (FIG.38.1)





TERRASOLO650 | 650 x 500 x 900 mm | HERITAGE FLAME - POLISHED (FIG.42.1)

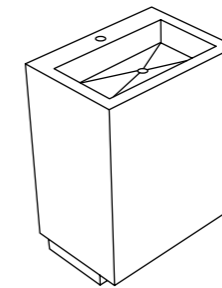

FREESTANDING BASINS

These freestanding basins are crafted from high-quality Italian porcelain slabs to bring a bold statement to any bathroom. Designed for both functionality and aesthetics, these basins are ideal for creating a striking centrepiece in modern spaces. Their standalone design allows for flexible placement within the bathroom, combining elegance with practical use in a variety of layouts.

Our freestanding basins are a great choice for both spacious and compact bathrooms. Whether positioned against a wall or in the middle of the room, these basins create a sense of openness and luxury. Their freestanding nature ensures they work well with a range of design styles, from minimalist to more traditional, allowing for greater creativity in bathroom planning.

Each basin can also be customised to suit different tap designs, offering compatibility with both wall-mounted, floor-mounted and deck-mounted taps, ensuring that your bathroom design can be perfectly aligned with your specific needs.



TERRASOLO650 | 650 x 500 x 900 mm | HERITAGE FLAME - POLISHED (FIG.44.1)



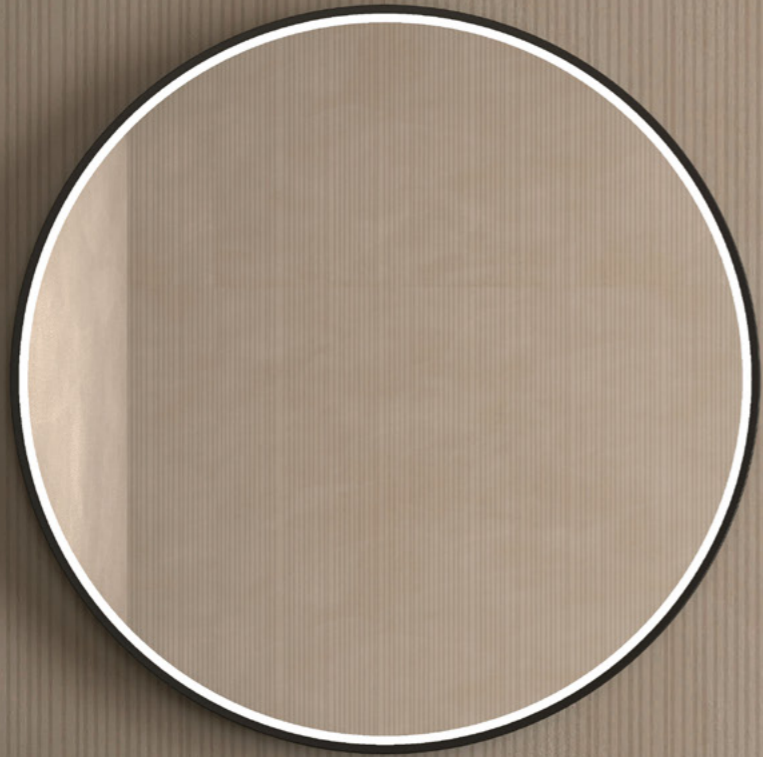

TERRASOLO650 | 650 x 500 x 900 mm | ONYX GREEN - POLISHED (FIG.48.1)







VANITYTOP1600 | 1600 x 500 x 130 mm | ONYX MIELE - POLISHED (FIG.54.1)

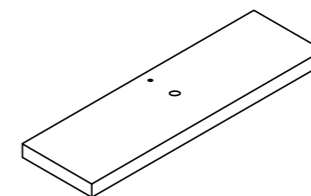

VANITY TOPS

Wall-mounted vanity tops, designed specifically for vessel basins, offering a flexible and elegant solution for modern bathrooms. Available in a variety of standard sizes, they provide versatility for different layouts and design needs. Wall-hung for a clean, space-saving installation, they are ideal for both residential and commercial bathroom projects where style and practicality are key.

Vanity tops can be specified to accommodate one or two deck-mounted vessel basins, with pre-drilled waste holes for seamless integration. This ensures quick and easy installation while maintaining a sleek appearance. Additionally, tap holes can be pre-drilled to match your specific application, allowing for complete customisation based on your design preferences and the overall bathroom setup.

These vanity tops, crafted from high-quality materials, are designed to provide both durability and sophistication. Whether for single or double basin configurations, they offer a practical, stylish solution that enhances the functionality and aesthetic of any bathroom space.



VANITYTOP1600 | 1600 x 500 x 130 mm | ONYX MIELE - POLISHED (FIG.56.1)



VANITYTOP1600 | 1600 x 500 x 130 mm | ONYX MIELE - POLISHED (FIG.58.1)



VANITYTOP2000 | 2000 x 500 x 130 mm | THUNDER NIGHT - POLISHED (FIG.60.1)









SOLO600 | 600 x 450 x 160 mm | STATUARIO MICHELANGELO - POLISHED (FIG.68.1)

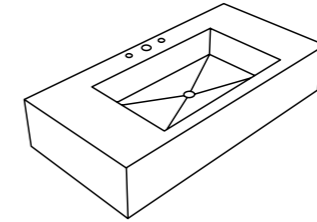

CLOAKROOM BASINS

A collection of basins with integrated sinks designed specifically for cloakrooms and small bathrooms. Crafted from premium Italian porcelain slabs, these compact solutions are perfect for maximising space while maintaining a stylish, modern aesthetic. Whether you opt for a vessel basin or a top with an integrated sink, each piece is carefully designed to fit seamlessly into smaller bathroom environments without compromising on functionality or elegance.

They can be installed within an alcove or wall-mounted for most efficient use of space. Vessel basins sit elegantly on the countertop, while integrated sink models offer a more streamlined, built-in appearance. Both options ensure a clean, contemporary look that suits any small bathroom design.

Basins and vanity tops can be specified for compatibility with both wall-mounted and deck-mounted taps, providing flexibility and design coherence even in smaller spaces.



SOLO800 | 800 x 500 x 160 mm | CALACATTA BLACK - POLISHED (FIG.70.1)



SOLO600 | 600 x 450 x 160 mm | STATUARIO MICHELANGELO - POLISHED (FIG.71.1)





SOLO800 | 800 x 500 x 160 mm | CALACATTA BLACK - POLISHED (FIG.74.1)



SOLO600 | 600 x 450 x 160 mm | STATUARIO MICHELANGELO - POLISHED (FIG.75.1)

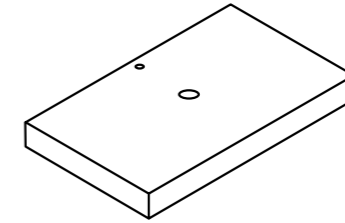

CLOAKROOM VANITY TOPS

A collection vanity tops designed specifically for vessel basins in cloakrooms and small bathrooms. Crafted from premium Italian porcelain slabs, these compact solutions are perfect for maximising space while maintaining a stylish, modern aesthetic. Each piece is carefully designed to fit seamlessly into smaller bathroom environments without compromising on functionality or elegance.

They can be installed within an alcove or wall-mounted to create an efficient use of space. Vessel basins sit elegantly on top, providing a clean, contemporary look that suits any small bathroom design. Countertops can be specified with both wall-mounted and deck-mounted taps, providing flexibility and design coherence in compact bathrooms.



VANITYTOP800 | 800 x 500 x 130 mm | REVE CHOCO - POLISHED (FIG.78.1)



VANITYTOP800 | 800 x 500 x 130 mm | PURESTONE GREY - NATURAL (FIG.79.1)





VANITYTOP800 | 800 x 500 x 130 mm | REVE CHOCO - POLISHED (FIG.82.1)



VANITYTOP800 | 800 x 500 x 130 mm | PURESTONE GREY - NATURAL (FIG.83.1)

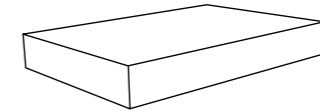

VANITY SHELVING

Finally we have a collection of versatile shelving solutions, designed to complement our range of vanity tops or serve as stand-alone storage. Available in a variety of standard sizes, these shelves offer both functionality and style, making them an ideal addition to modern bathroom spaces. Whether used for extra towel storage or as a decorative feature, they provide a practical solution that seamlessly integrates with your bathroom design.

When paired with a wall-mounted vanity top, the shelves create a cohesive look, enhancing both storage capacity and aesthetic appeal. These shelves are perfect for maximising space and maintaining a clean, organised bathroom, offering flexibility in layout and use.



VANITYSHELF1200 | 1200 x 500 x 60 mm (FIG.86.1)

VANITYSHELF1600 | 1600 x 500 x 60 mm | HERITAGE AZURE - POLISHED (FIG.87.1)



VANITYSHELF1200 | 1200 x 500 x 60 mm (FIG.88.1)

VANITYSHELF1600 | 1600 x 500 x 60 mm | HERITAGE AZURE - POLISHED (FIG.89.1)

CLICK-CLACK COLOURS

All basins are supplied with a high quality click-clack slotted basin waste. These can be specified with a bronze, brushed brass, matt black, gun metal, chrome or matt white finish.



BRONZE

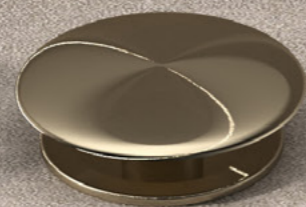

BRUSHED BRASS



MATT BLACK



GUN METAL



CHROME



MATT WHITE



DIMENSIONS

Basins and vanity tops are offered in the following standard sizes. Custom configurations can be supplied from your own technical drawings. Lengths longer than 3000 mm require a joint.

NAME	DESCRIPTION	LENGTH MM	DEPTH MM	HEIGHT MM	SINK	WEIGHT KG
Solo450	Cloakroom Single Basin	450	300	160	Single	30
Solo600	Small Single Basin	600	450	160	Single	40
Solo800	Medium Basin	800	500	160	Single	45
Solo1200	Lux Single Basin	1200	500	160	Single	50
Solo1400	Lux Single Basin	1400	500	160	Single	55
Solo1600	Lux Single Basin	1600	500	160	Single	60
Doppio1400	Small Double Basin	1400	500	180	Double	60
Doppio1600	Medium Double Basin	1600	500	180	Double	65
Doppio2000	Large Double Basin	2000	500	180	Double	70
TerraSolo650	Floorstanding Basin	650	500	900	Single	50
VanityTop600	Vanity Top	600	500	130	-	15
VanityTop800	Vanity Top	800	500	130	-	20
VanityTop1200	Vanity Top	1200	500	130	-	30
VanityTop1400	Vanity Top	1400	500	130	-	35
VanityTop1600	Vanity Top	1600	500	130	-	40
VanityTop2000	Vanity Top	2000	500	130	-	50
VanityShelf600	Vanity Shelf	600	500	60	-	9
VanityShelf800	Vanity Shelf	800	500	60	-	12
VanityShelf1200	Vanity Shelf	1200	500	60	-	18
VanityShelf1400	Vanity Shelf	1400	500	60	-	21
VanityShelf1600	Vanity Shelf	1600	500	60	-	25
VanityShelf2000	Vanity Shelf	2000	500	60	-	30



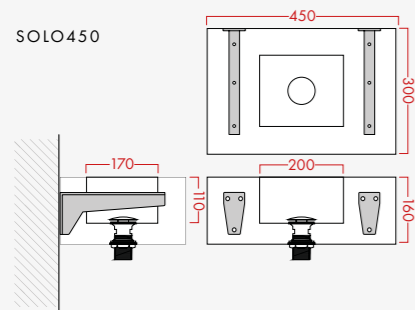

All sink openings 500 x 325 mm
 Except Solo450 which is 200 x 170 mm
 And Solo600 which is 370 x 270 mm
 All sink depths 110 mm

All dimensions shown in mm. Please note that while every effort will be made to supply goods to the size and colour specified, due to the handmade nature of these items, slight variations may occur. We adhere to a dimensional tolerances limit of $\pm 0.3\%$. It is also impossible to choose a specific graphical face or area of the tile and its location within the item. Where sizes are specified these are assumed to be the total dimensions to be made including any fixtures or fittings. All wall-mounted vanity basins and countertops are supplied with L-Bracket wall-fixings. Shelves are supplied with wall-plugs.

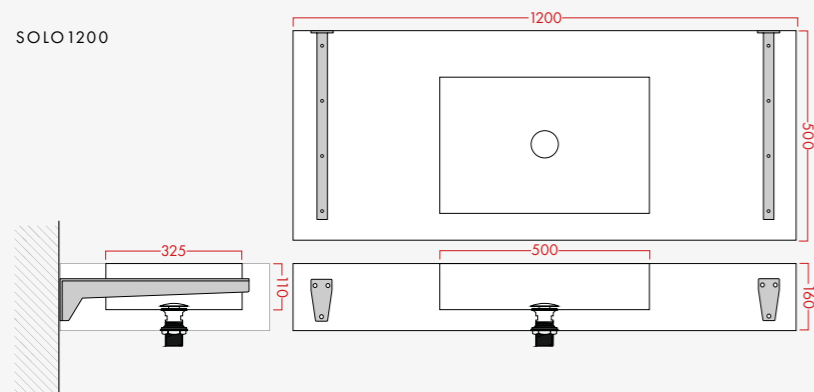
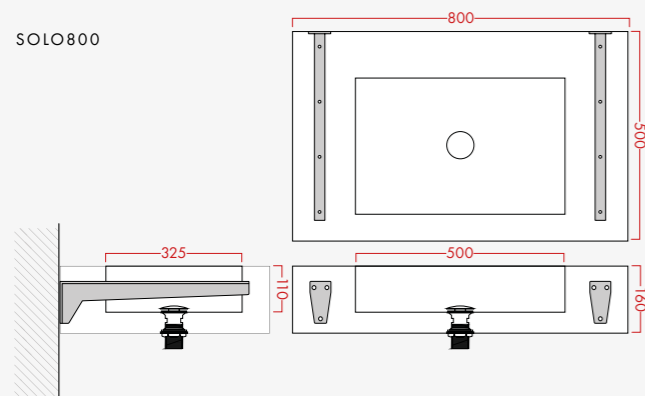
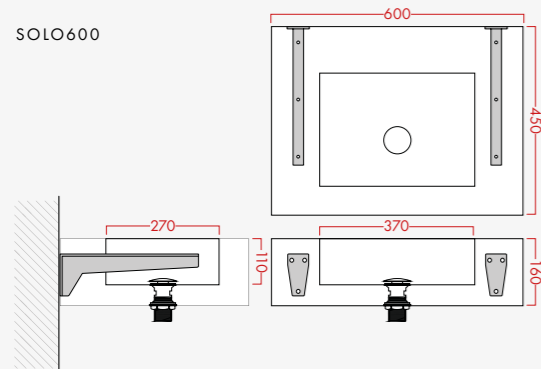

WALL FIXING L-BRACKET

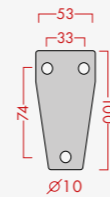

SOLO (FIG.95.1)



DOPPIO (FIG.95.2)



TERRASOLO (FIG.95.3)



VANITYTOP (FIG.95.4)

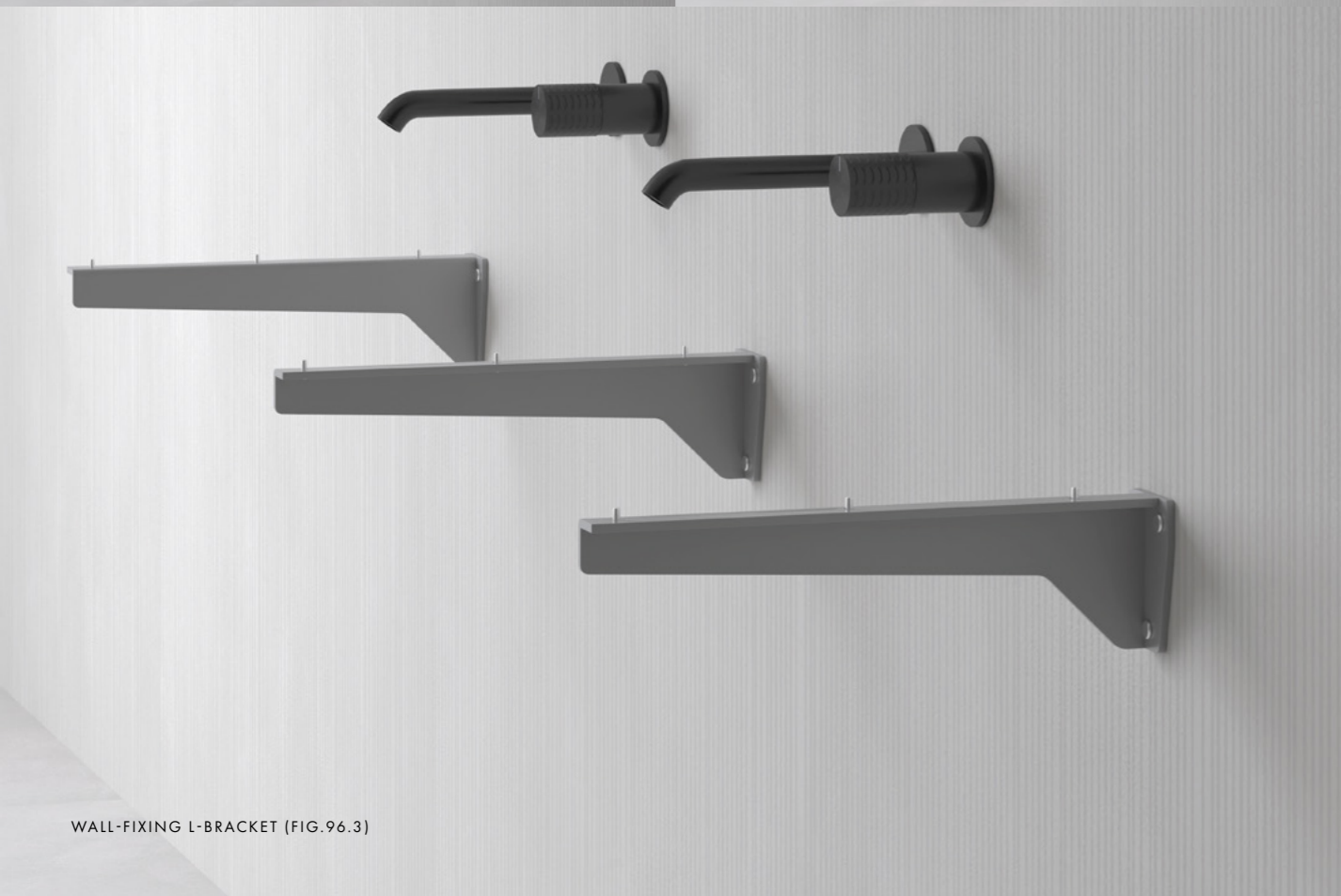

WALL-FIXING L-BRACKET (FIG.96.3)

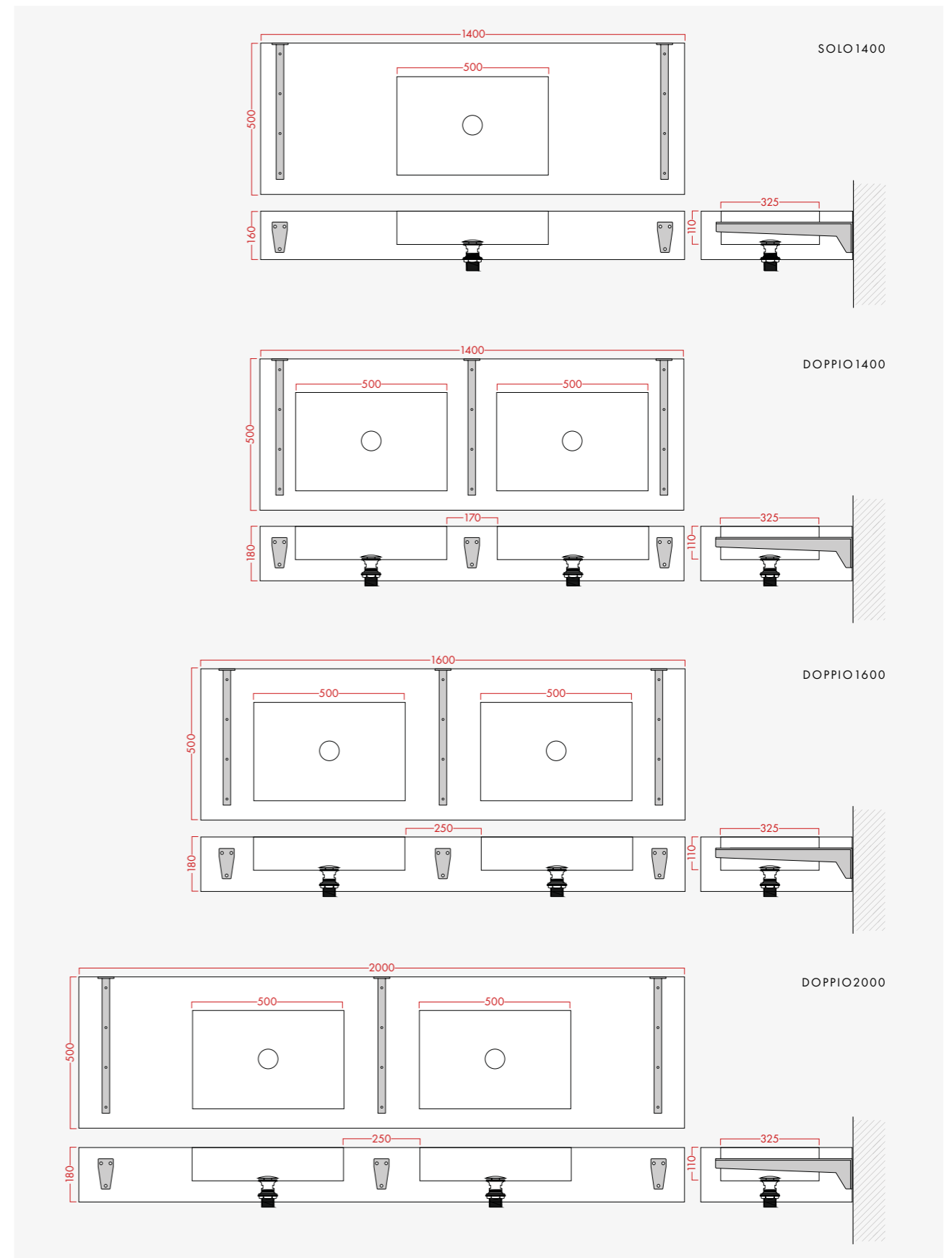

VANITYTOP1400

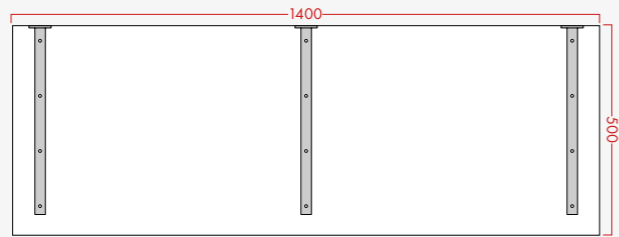

VANITYSHELF1400

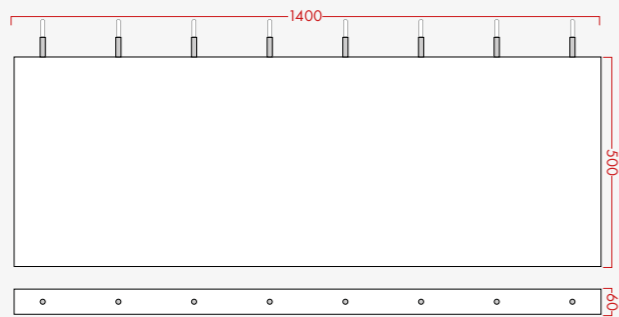

TERRASOLO650

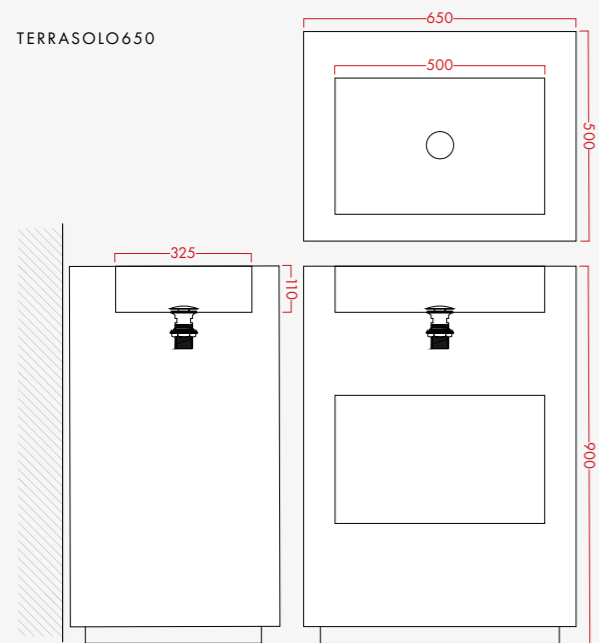

TerraSolo has a door to the rear to access the waste for installation and maintenance. All dimensions shown in mm. Please note that while every effort will be made to supply goods to the size and colour specified, due to the handmade nature of these items, slight variations may occur. We adhere to a dimensional tolerances limit of $\pm 0.3\%$. It is also impossible to choose a specific graphical face or area of the tile and its location within the item. Where sizes are specified these are assumed to be the total dimensions to be made including any fixtures or fittings. All wall-mounted vanity basins and countertops are supplied with L-bracket wall-fixings. Shelves are supplied with wall-plugs.



SOLO (FIG.99.1)



DOPPIO (FIG.99.2)



TERRASOLO (FIG.99.3)



VANITYTOP (FIG.99.4)





TAILOR-MADE⁺

Through a trusted and professional service, Tailor-made⁺ enables its clients to harness the beauty and practicality of high-performance porcelain slabs.

Our solutions serve a wide range of industries, providing the crucial link between idea, design, and realisation. We have developed an extensive range of practical solutions, including cut-to-size services, product design and manufacturing, that have been tailored to the specific needs of each sector.

Design, cutting, and fabrication projects are carried out by a highly skilled team at our purpose-built studio, right here in the UK. Uniquely, this facility is located on the same premises as our substantial slab warehousing, providing unparalleled access to the expertise, machinery and surfaces all under one roof.

With no minimum order quantities, short lead times, and repeat orders maintained within strict tolerances, integrating porcelain stoneware into your products is a risk-free decision for both you and your clients, ensuring satisfaction from the point of purchase through the product's entire lifespan.



VANITYTOP800 | 800 x 500 x 160 mm | PURESTONE GREY - NATURAL (FIG.104.1)

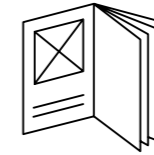

MARKETING SUPPORT

To support our products and surfaces we provide formulated marketing support that is tailored to your industry. We have 3D models of all items to incorporate into CGI scenes and can supply product thumbnails and close-ups for your mood boards.

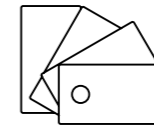

SAMPLES

With so many colours, styles and finishes to choose from, your clients need to view accurate colour samples. To answer this need we provide you with access to a colour samples service that is relevant to the needs of your industry. This ensures that your customers are able to make informed choices based on actual material swatches.

TECHNICAL SPECIFICATION

View technical information about the specifications of porcelain stoneware.

THICKNESS	12mm	6mm
MAXIMUM SLAB DIMENSIONS	320 x 160 cm	320 x 160 cm
WEIGHT	28 kg per m ²	14 kg per m ²

This table serves as a reference for the technical data listed and contains data provided by the International Organisation for Standardisation (ISO).

TEST	TEST METHOD	RESULT
Water absorption	ISO 10545-3	≤ 0.1%
Deep abrasion resistance	ISO 10545-7	2-5
Stain resistance	ISO 10545-14	Resistant
Chemical resistance	ISO 10545-13	Conforms
Resistance to thermal shocks	ISO 10545-9	Resistant
Frost resistance	ISO 10545-12	Conforms

The following table is the Mohs scale of hardness ranging from 1 to 10 used to determine a material's scratch resistance. The Mohs scale uses ten fairly common minerals of known hardness and gives each of them a relative value of 1-10. Each mineral in the scale will scratch those with lesser values and will not scratch those with higher values.

Porcelain stoneware is considered to have a Mohs rating of 8.

MOHS RATING	MINERAL	VANITY TOP SURFACE
1	Talc	Vinyl
2	Gypsum	Wood tops
3	Calcite	Marble and Laminate
4	Fluorite	Marble and Corian
5	Apatite	Granite tops
6	Feldspar	Granite tops
7	Quartz	Quartz or Quartzite tops
8	Topaz	Porcelain stoneware
9	Corundum	No top is this hard
10	Diamond	No top is this hard





MAINTENANCE

Porcelain stoneware surfaces are virtually maintenance free, extremely hard wearing and do not require sealing or periodic re-sealing. A comprehensive cleaning routine will help to keep your surfaces in tip-top condition and ensure their continued beauty for years to come. For everyday cleaning we recommend the use of warm water and a soft microfibre cloth. Dry with a second microfibre cloth and if your surface is polished, buff to restore the brilliant finish.

Before using any new cleaning product or method, make sure to test it on a small, inconspicuous area of the surface first. Avoid using excessively acidic or basic products, and do not use abrasive sponges. We do not recommend the use of polishing machines or waxes.

Although porcelain is stain resistant, care must be taken to immediately clean any stain, especially on polished tops. The best way to ensure stubborn marks do not occur is to wash away stains such as red wine, food and drinks, using warm water and a soft microfibre cloth. For stubborn stains use a non-abrasive cleaning product, sugar soap or normal house cleaning products.

Do not use cleaners that have strong alkaline pH levels and thoroughly rinse the surface with clean water to remove residue. It is also important to note that hydrofluoric acid (HF) and its derivatives can irreparably damage porcelain stoneware. For all cleaning operations, it is recommended to carry out a preventive test on a small part of material and leave the product on only as necessary.

For the regular maintenance of kitchen and eating areas, promoting shine and hygienic cleanliness and to remove lime scale, grease deposits and soap use a specialist cleaner. We recommend specialist ceramic cleaning products from Fila Solutions and Lithofin.

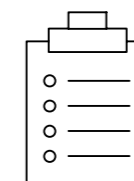

THINGS TO AVOID

- Avoid polishing wax or any impregnating products as their application is unnecessary.
- Avoid steel wool and abrasive products of any kind.
- Avoid chemical cleaners, bleaches or detergents containing chlorine or any of its derivatives except those mentioned in this document.
- Avoid leaving food or other liquids with corrosive properties such as juices, salt, vinegar or mustard on the surface for extended periods.
- Avoid shocks in the most delicate points of the surfaces such as corners and edges.
- Avoid dropping heavy or sharp objects on the surface.
- Avoid heavy loads on the surface. Particularly on overhanging areas and joints.
- Avoid sitting or standing on the surface.
- Avoid large quantities of water on the surface, and do not let water seep into the joints, edges and critical points.



RECOMMENDED DETERGENTS FOR VANITY TOPS

If basic cleaning is not sufficient to remove the most persistent encrustations, it is possible to intervene locally as indicated in the table below using a slightly abrasive sponge then, if necessary, combine the sponge with a degreasing product.

TYPE OF STAIN	STAIN REMOVER
Limescale deposits	Neutral detergent Acid detergent
Coca-cola Lemon Coffee Juices Ice cream Wine Grease Vinegar/oil Ketchup	Neutral detergent Cream cleanser Alkaline detergent Solvent
Permanent marker	Neutral detergent Solvent



MEETING YOUR SUSTAINABILITY GOALS

All our porcelain surfaces are manufactured using sustainable processes that minimise the impact on the environment, conserving both energy & natural resources.

Surfaces are produced without the use of any harmful or radioactive materials, are free from pollutant emissions and will not effect air quality. All packing material is produced with recycled material. Wherever possible, heat generated as a by-product of the surface manufacturing process is used for electricity generation, making their factories energy self sufficient. All waste material that is associated with the supply of the tile surface is fully recyclable.

All surfaces are manufactured using materials from renewable sources. They have a reduced environmental impact throughout their lifespan and no toxic, harmful or polluting substances are used for their composition and production. The materials do not release toxic, harmful or polluting substances. All products meet the highest standards of quality and environmental regulations and conform to the following certifications:



BREEAM®





VANITYTOP1600 | 1600 x 500 x 130 mm | ONYX MIELE - POLISHED (FIG. 116.1)

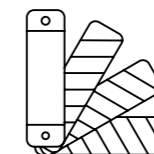

ENDLESS COLOUR POSSIBILITIES

The following porcelain stoneware colours represent the latest generation of surface materials to combine vibrant designs with increased technical performance. From classic marbles to precious stone, concrete and wood, there is a wide range of colours and styles to suit your design requirement. Whichever colour you choose, all offer the practical benefits of porcelain and provide a virtually maintenance-free, non-porous surface that is highly resistant to water, stains and scratches. This allows you to enjoy the beauty of marble, the texture of stone or the heft of concrete, without any of the production, maintenance or environmental issues.

Some colours are available with a choice of surface finish (Natural, Polished or Silk), providing you with fine control over the visual impact and tactile feel of the product in which it is integrated.



CALACATTA BLACK
POLISHED | NATURAL



SAHARA NOIR
POLISHED | SILK



THUNDER NIGHT
POLISHED | NATURAL



SMOKY BLACK
POLISHED



CALACATTA RENOIR
POLISHED

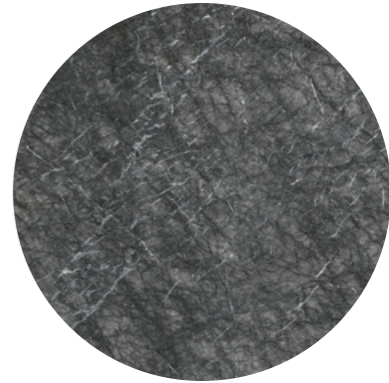

GRIGIO CARNICO
POLISHED



HERITAGE FLAME
POLISHED | NATURAL

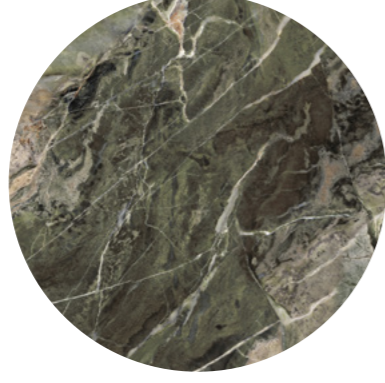

HERITAGE EMERALD
POLISHED | NATURAL

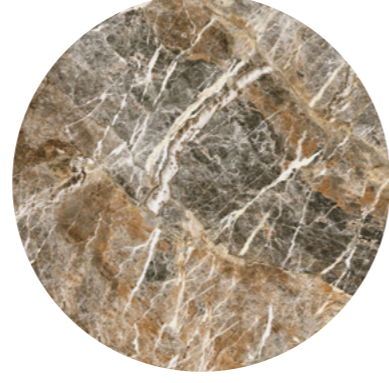

MOUNTAIN PEAK
POLISHED | NATURAL

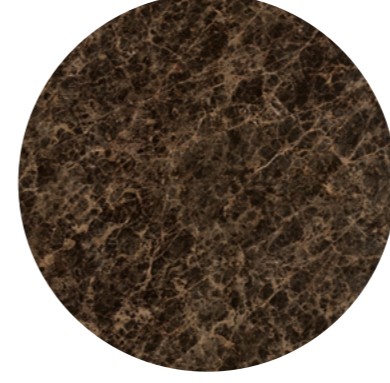

DARK EMPERADOR
POLISHED

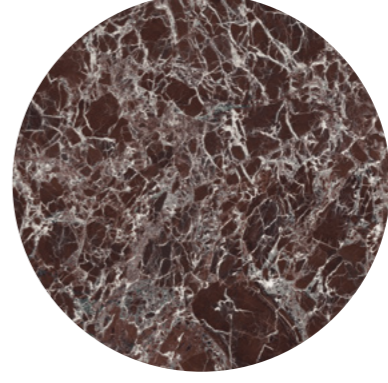

ROSSO IMPERIALE
POLISHED | NATURAL

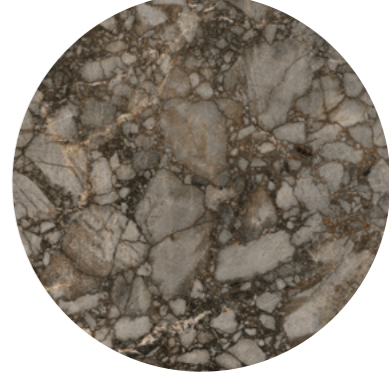

RIVERBED
POLISHED | NATURAL

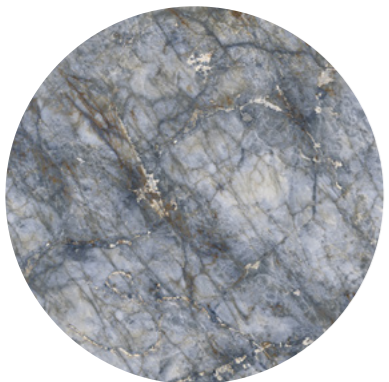

GRANITO BLU ANDE
POLISHED

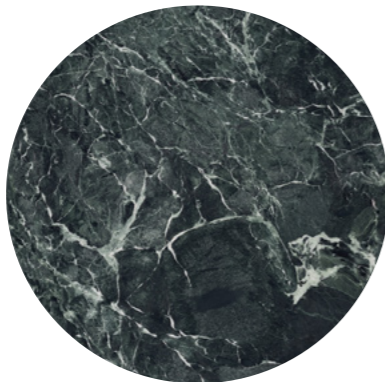

VERDE ST. DENIS
POLISHED | NATURAL

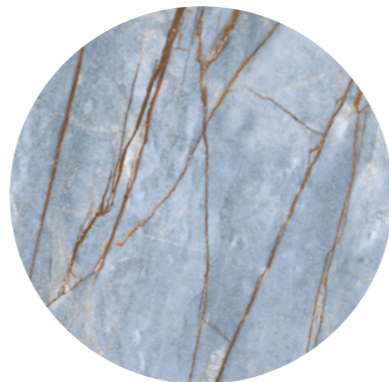

HERITAGE AZURE
POLISHED | NATURAL



ONYX GREEN
POLISHED

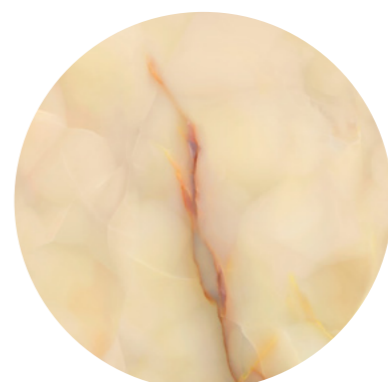

ONYX MIELE
POLISHED

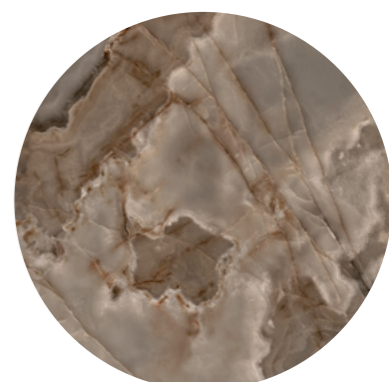

REVE CHOCO
POLISHED | NATURAL



ONYX PERLA
POLISHED | SILK



SAGE
POLISHED



CALACATTA GOLD
POLISHED | NATURAL



CRYSTAL AMBRA
POLISHED | NATURAL

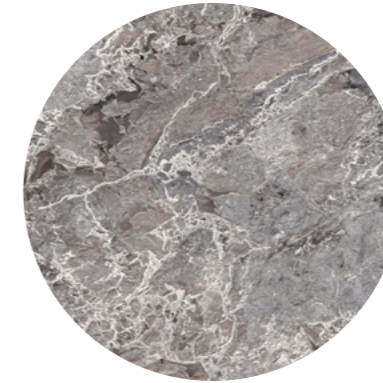

MARBLE AUBISQUE
POLISHED | SILK



MOON GREY
POLISHED | NATURAL



STATUARIO EXTRA
POLISHED



STATUARIO MICHELANGELO
POLISHED | NATURAL



CALACATTA GOLD CANOVA
POLISHED



MACCHIA VECCHIA
POLISHED



TUNDRA
POLISHED | NATURAL

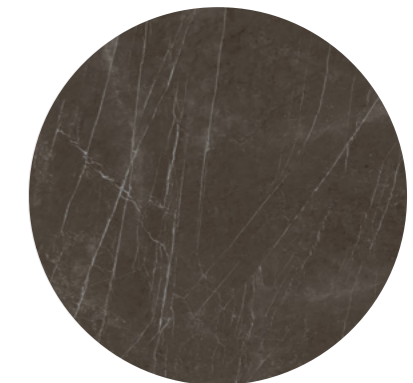

PIETRA GREY
POLISHED | NATURAL | SILK



BROWN ROCK SALT
POLISHED

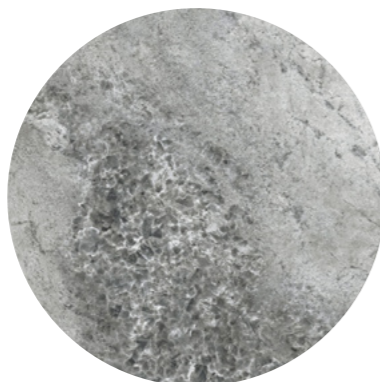

CRYSTAL DARK
POLISHED



GREY ROCK SALT
POLISHED



ONICE KLIMT
POLISHED

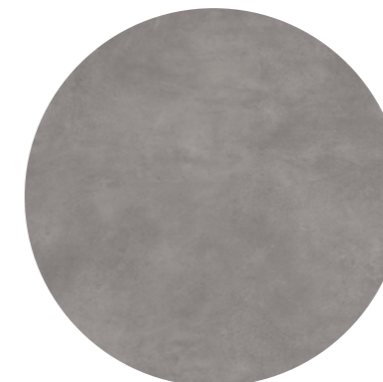

CONCRETE DARK GREY
NATURAL



LAPIS GREIGE
NATURAL | SILK



GOLD TRAVERTINE
NATURAL | SILK | SOFT



PEARL TRAVERTINE
NATURAL | SILK | SOFT



WHITE VEIN CUT
POLISHED | NATURAL

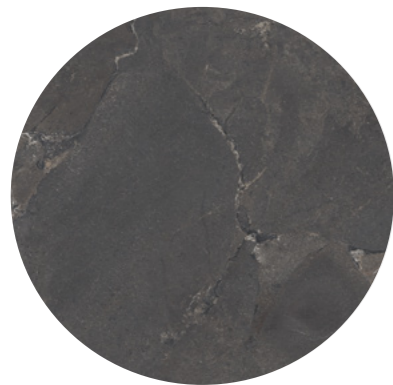

PURESTONE BLACK
NATURAL



PURESTONE GREY
NATURAL

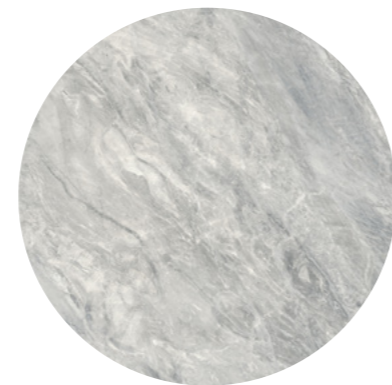

BARDIGLIO CHIARO
POLISHED | NATURAL



STONE CHABLIS
NATURAL | MATTE LEATHER



STONE MONTPELLIER
NATURAL | MATTE LEATHER



VARIEE BLANC
NATURAL



VANITYTOP2000 | 2000 x 500 x 130 mm | THUNDER NIGHT - POLISHED (FIG.123.1)

design@tailormade.uk
020 3848 5212

tailormade.uk

@tailormadeuk

Tailor-made Ltd
65 Bridge Street
Chatteris PE16 6RD

TAILOR-MADE⁺

The information printed in this brochure is as accurate as possible at the time of printing, but should not be considered as legally binding. The company reserves the right to modify, change, or cancel the content of this brochure without prior notice. The technical details mentioned cancel and replace the ones reported previously and where dimensions or sizes are specified, they shall be deemed to be nominal. The images, colours and finishes featured are for illustrative purposes only and may feature products that are not currently available. Quoted prices correct at time of printing. All rights reserved. V.25.050

