

TAILOR-MADE⁺

INSTALLATION GUIDE

Thank you for purchasing an item from **TAILOR-MADE⁺**

The purpose of this guide is to provide general instructions for the successful installation of your bespoke item. Before attempting your installation, please ensure that you have the correct tools outlined in our guide and that the support structure to which it will be fixed has been checked and verified by a structural engineer. There are six steps to follow. Please follow each step carefully and in full.

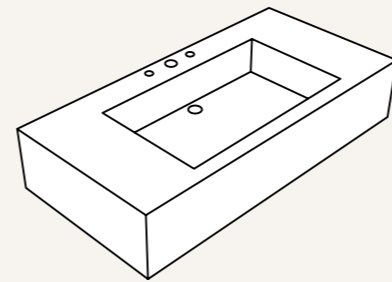

Wall-mounted Basins

© All rights reserved.

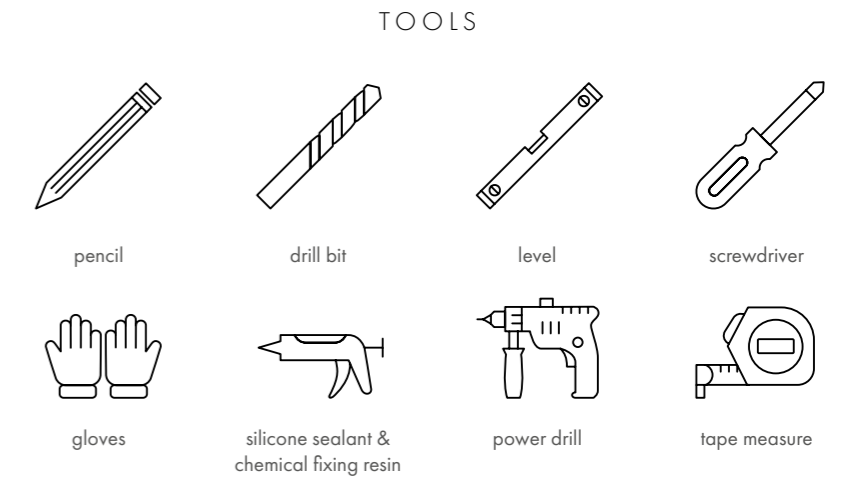
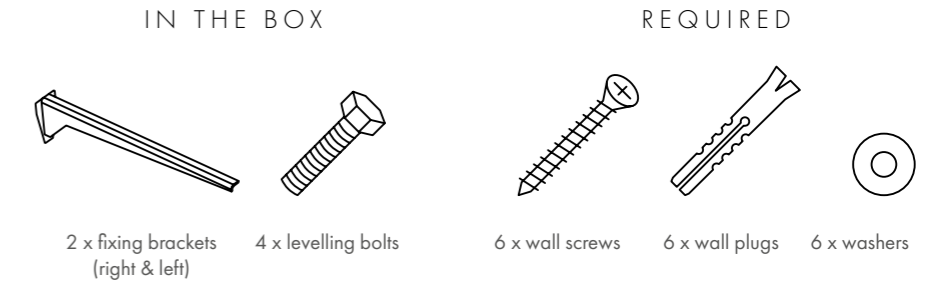

Missing hardware? Please email your agent for replacements.

GETTING STARTED

This guide lists all the contents included in the box. Please take the time to identify the hardware as well as the individual components to this product. As you unpack and prepare for assembly, place the contents on a clean, padded surface to protect them from damage.

Please note this product is fragile. To avoid breakage and possible injury handle with care. Two people are required to safely install this product. For heavy items use gloves.

If installing a basin, please check that the drain valve is attached to the bottom of the unit.

1 Fixing brackets

There are two fixing brackets, one for the left and one for the right hand side of your basin. Placement of the basin should be considered before fixing brackets. Typically basins should be installed at a height of 85 cm to the top surface. Mark the three screw hole positions for each bracket flange on the wall using a pencil.

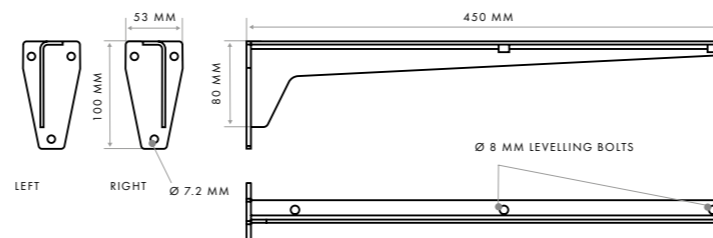

Only once the fixing brackets have been securely mounted, should tiles be fixed to the wall. If installation is for a twin washbasin, it will be necessary to place a third wall bracket (supplied) so that the weight is evenly distributed. See step 6.

2 Drill fixing points into wall

The left and right fixing brackets must be placed as shown below. The distance between each bracket will be documented on your technical specification document. Drill mounting holes using suitable screws and wall plugs for your wall type and item weight.

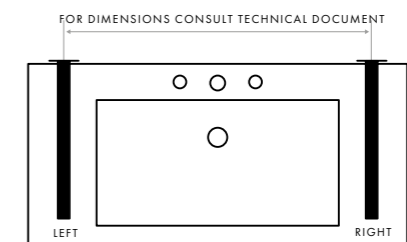

Due to the considerable weight of this item, the wall or support structure to which it will be fixed must be checked and verified by a structural engineer. The installation should only commence once supporting walls meet the necessary standards.

3 Mount fixing brackets to wall

Insert wall anchors or wall plugs into each marked hole. Mount the fixing brackets to the wall using a screwdriver. Use a level to ensure that the two brackets are perfectly level. Secure, but do not over tighten screws with a screwdriver. Insert two threaded levelling bolts into each bracket which will be used to finely adjust the basin level.

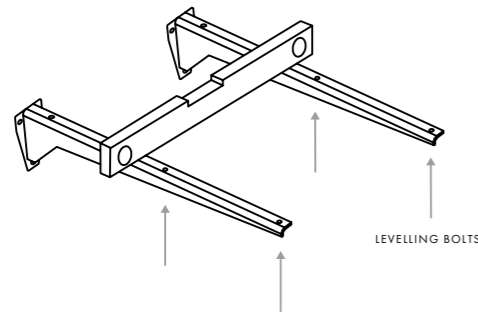

These instructions are for drywall mounting only. For safe installation it is essential to use hardware appropriate for your wall type. If you are unsure of what type of fasteners to use, consult a qualified professional.

4 Attach basin to fixing brackets

Before positioning the basin, apply chemical fixing resin on the upper edge of each fixing bracket and on the internal perimeter edge of the basin countertop. With two people, manoeuvre the basin on to the brackets, leaving a minimum joint of 3 mm between the basin and the wall. Using a level, adjust the threaded bolts on each bracket to ensure basin is perfectly level.

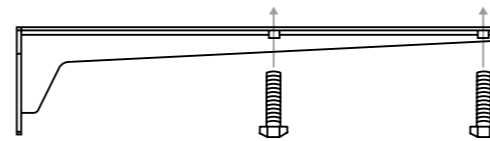

When wall-mounting ensure that all electrical works, wall plumbing and pipe works have been carried out prior to installation.

5 Attach plumbing & clean

Install the tap fittings and drain connections, faucet and waste assembly according to manufacturer's instructions. Connect hot & cold supplies and drain pipe. All basins are supplied with a pre-installed 1 1/4" unslotted click clack basin waste, sealed with silicon.

Finally clean the item and surrounding area with warm water and a soft microfibre cloth and ensure all surfaces are dry. Carefully seal the area between the washbasin and the wall with silicone.

Turn on water and check for leaks.

For fixed base and hidden waste basins, water flows through a thin channel into an unseen INOX steel sink bowl and waste system, accessible from underneath the item.

6 Double-width basins

Depending on the length and weight of your basin there may be a third fixing bracket. This will be documented in your technical specification. If this is the case ensure to install the centre bracket using the same process.

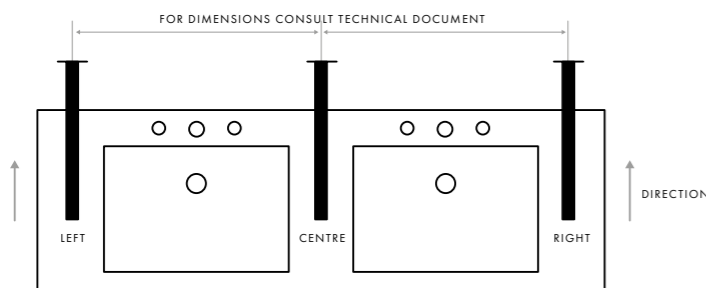

If you have any queries regarding the installation of your item, please contact our technical department.

CLEANING & CARE

The porcelain surface of this item requires almost no maintenance and provides a high level of stain and scratch resistance. General cleaning of your item is a relatively simple process and is the best way of preventing a build-up of dirt and unsightly stains. For everyday cleaning we recommend the use of warm water and a soft microfibre cloth. Dry with a second microfibre cloth and if your surface is polished, buff to restore the brilliant finish.

Do not use abrasive cleaners and avoid dropping heavy or sharp objects on the surface. Before using any new cleaning product or method, make sure to test it on a small, inconspicuous area of tiling first. Avoid using excessively acidic or basic products and do not use abrasive sponges. Sealants are not required.

For the regular maintenance of kitchen and bathroom areas, promoting shine and hygienic cleanliness and to remove lime scale, grease deposits and soap use a specialist cleaner. We recommend specialist ceramic cleaning products from Fila Solutions and Lithofin.



WARRANTY

Your Tailor-made* product is covered by a limited 10 Year limited warranty ensuring that it will be free from manufacturing defects and be able to perform in service when properly installed and maintained. If a manufacturing defect occurs during the warranty period, we will at our option, repair or replace the defective surfaces. This warranty does not cover products exposed to abnormal use or conditions or abuse in any way.

DISCLAIMER

This information should be considered to be informal and non-binding. Always test cleaning products in an inconspicuous area and always follow manufacturers instructions. These products must be used according to local conditions and materials. We cannot accept any responsibility for reliance placed upon the advice contained herein since practical expertise and site conditions are outside of our control. This does not affect your statutory rights. The company reserves the right to modify, change, or cancel the content of this document without prior notice.

CONTACT

For further information regarding this product please contact your agent.